

SNP-Z10H-M SPECIFICATION

SPECIFICATION

and

PERFORMANCE

for

SWITCHING POWER SUPPLY

M/N : SNP-Z10H-M

| | | | | | | |
|--------------------------------|---|---|---|--|---|--|
| Reviewed by Project Manager |  07/21/03 |  11/27/08 |  11/23/11 |  1-4-19 |  7-21-24 | |
| Typed by Document Assistant |  08/19/03 |  11/26/08 |  11/22/11 |  01/04/19 |  07/28/24 | |
| SKYNET ELECTRONIC | | | LAST REV. NO. | | | |

1.0 INTRODUCTIONS

The SNP-Z10H-M is one of the SNP-Z10*-M series, which is a single output medical switching power supply and designed to meet Harmonics EN61000-3-2 class D.

2.0 INPUT SPECIFICATIONS

2.1 Input Voltage

- a. The range of input voltage is from 90VAC to 264VAC. The nominal voltage is 115VAC 60Hz and 230VAC 50Hz. Label: 100~250VAC.
- b. The DC Input is from 130 ~370VDC.

2.2 Input frequency

The range of input frequency is from 47Hz to 63Hz.

2.3 Input current

The maximum input current is 2.6A at 115VAC or 1.3A at 230VAC.

2.4 Inrush current

The inrush current is 30A max at 115VAC, 60A max at 230VAC, cold start at 25 degree C.

2.5 Earth Leakage

250uA max. at 240VAC, 60Hz.

3.0 OUTPUT SPECIFICATIONS

3.1 Load range

| output | min. load | rated load | max. load | Total Tolerance |
|--------|-----------|------------|-----------|-----------------|
| +28V | 0A | 3.8A | 4.65A | + -1% |

At factory, the output in 60% rated load and nominal line condition, the +28V output is set to between 27.80 and 28.20V.

3.2 Output power

The max. power is
 120W that works with 10CFM air forced cooling.
 130W that works with 18CFM air forced cooling.

3.3 Ripple and noise

The peak to peak ripple and noise for the output is less than 100mV at rated load and nominal line. Measuring is done by 15MHz band width limited oscilloscope and terminated the output with a 47uF + 0.47uF capacitor.

3.4 Line regulation

The line regulation is less than + -0.5%, measuring at rated load and changing input voltage from 90 ~ 264V.

3.5 Load regulation

The load regulation for +28V is + -1%, measuring is done by changing the measured output load + -40% from 60% rated load while the input at nominal line.

3.6 Remote sense

The compensation of voltage drop the +28V output is 0.5V max.

The +28V output has remote sense capability.

3.7 Capacitance loading capability

The capacitance loading capability can be up to 2700uF, test at nominal line and rated load.

4.0 GENERAL FEATURES**4.1 Efficiency**

The efficiency is 85% Typ. by measuring at nominal line and rated load.

4.2 Hold up time

The hold up time is 20mS typ at 115VAC input and rated load which is measured from the end of the last charging pulse to when the main output drops down to 95% output voltage.

4.3 Protection**a. O.V.P**

The build-in over voltage protection circuit will shut down the outputs to prevent damaging external circuits, the trigger point is around 30V to 34V for +28V output.

b. O.C.P

The power supply will go into auto-recovery mode against short circuit or over load conditions.

The trigger point is 110% ~ 130% of max (130W) load.

4.4 Transient Response

Less than 4% deviation with a 25% load change at 1A/uS. Output returns to within 1% in less 500uS

4.5 Stability

Output drift < +/-0.2% after 20 min warm up.

4.6 Temperature Coefficient

+/-0.05 per °C

5.0 ENVIRONMENT SPECIFICATIONS**5.1 Operating temperature**

0°C to 50°C no derating, above 50°C derate 2.5% /C up to 50% at 70°C.

100W with convection cool.

120W with 10 CFM air Flow.

130W with 18 CFM air Flow.

The air direction is from the side of PCB.

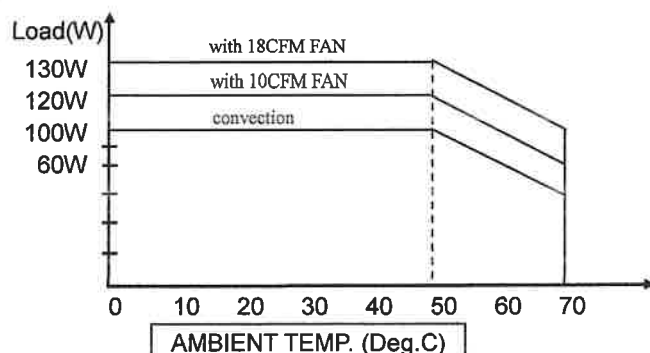

5.2 Storage temperature

-40°C to 85°C

5.3 Operating humidity

5 ~95% RH, non-condensing .

6.0 INTERNATIONAL STANDARDS**6.1 Safety standards**

Designed to meet the following standards:

3 Edition:

UL: ANSI/AAMI ES60601-1(2005+C1:09+A2:10)

CSA: CAN/CSA-C22.2 No. 60601-1 (2008)

TUV: EN 60601-1:2006

CB: IEC 60601-1:2005

3.1 Edition:

UL: ANSI/AAMI ES60601-1(2005+C1:09+A2:10+A1:12)

CSA: CAN/CSA-C22.2 No. 60601-1 (2014)

TUV: EN 60601-1:2006+A1:2013+A12:2014+A2:2021

CB: IEC 60601-1:2005+A1:2012

3.2 Edition:

UL: ANSI/AAMI ES60601-1:2005/(R)2012 and A1:2012/(R)2012 and A2:2021 CSA:
C22.2 No. 60601-1 (Amendment 2:2022 (MOD) to CAN/CSA-C22.2 No. 60601-1:14

TUV: EN60601-1:2006+A1:2013+A12:2014+A2:2021

CB: IEC 60601-1:2005+A1:2012+A2:2020

6.2 EMI standards

Designed to meet the following limits :

FCC docket 20780 curve "B"

EN 55011 "B"

EN 60601-1-2

EN 61000-3-2

EN 61000-3-3

6.3 EMS standards

Designed to meet the following standards :

| | | |
|--------------|---|-------------|
| EN61000-4-2 | 8KV contact discharge, 15KV air discharge | Criterion A |
| EN61000-4-3 | 10V/m | Criterion A |
| EN61000-4-4 | 2KV (100KHz) | Criterion A |
| EN61000-4-5 | 2KV | Criterion A |
| EN61000-4-6 | 10V with 80% AM | Criterion A |
| EN61000-4-8 | 30A/M | Criterion A |
| EN61000-4-11 | 30 % dips 500 ms, | Criterion A |
| | 60 % dips 200 ms, | Criterion B |
| | 100 % dips 5000 ms, | Criterion B |
| | 100 % dips 200 ms, | Criterion B |
| | 100 % dips 10 ms, | Criterion A |

7.0 MECHANICAL SPECIFICATION

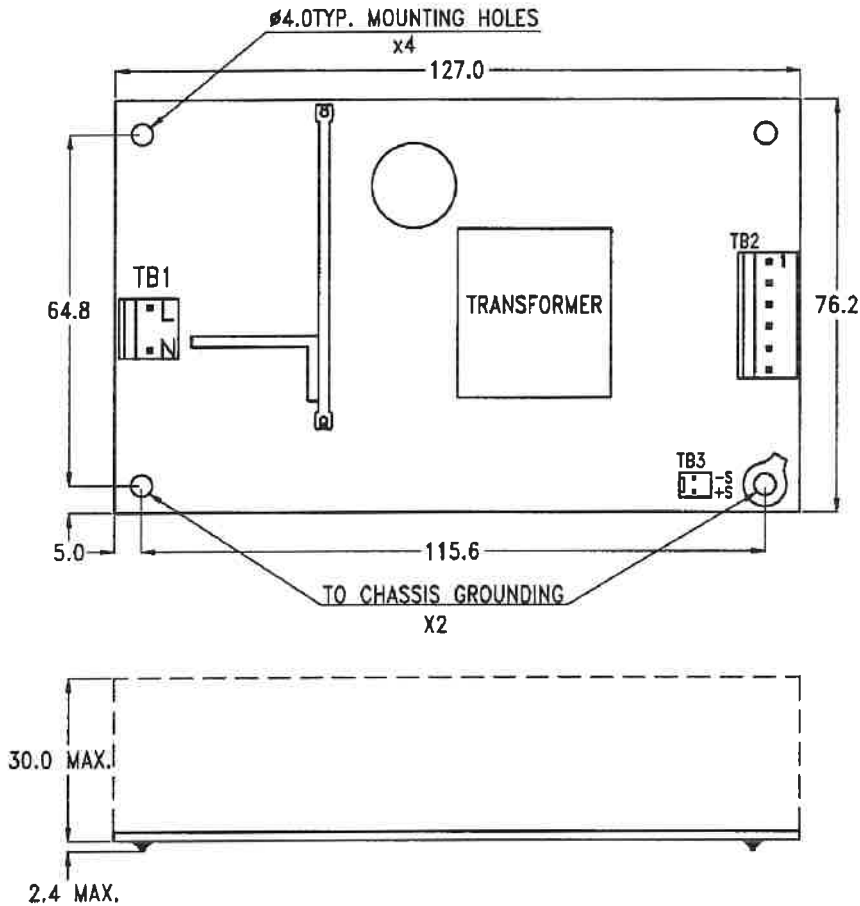

7.1 Dimensions

Dimensions shown in mm as above. Tolerance specified is + -0.4mm.

7.2 Connectors

- TB1--AC input : Molex 5277-02A or equivalent
- TB2--DC output : Molex 5273-06A or equivalent
- TB3--Remote Sense : Molex 5045-02A or equivalent

7.3 DC output pin assignment

- Pin 1. +28V 5. GND
- 2. +28V 6. GND
- 3. +28V
- 4. GND

7.4 Packing

- Net weight : 254g approx. / unit
- Carton size (mm) : 397 (L) x 339 (W) x 327 (H)
- Quantity : 48 units / carton
- Gross weight : 15.0 kg approx. / carton

8.0 PERFORMANCE (input voltage is 115VAC, unless others specified)

8.1 Switching frequency ripple

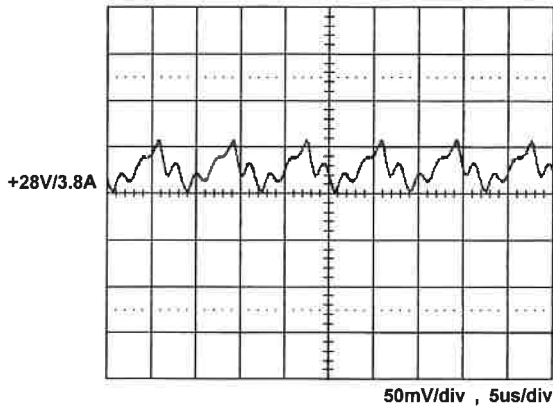

8.2 Line frequency ripple

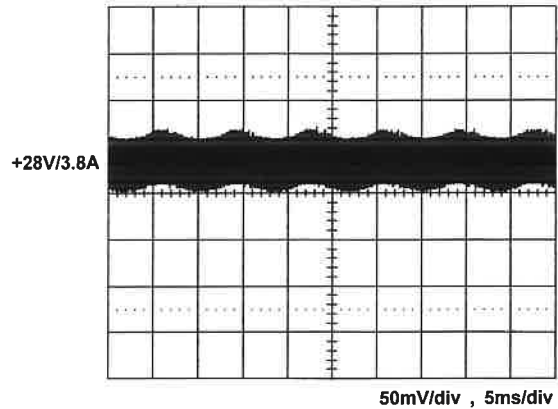

8.3 Output turn on wave form

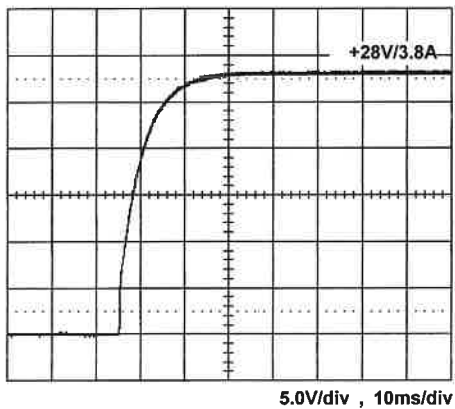

8.4 Output turn off wave form

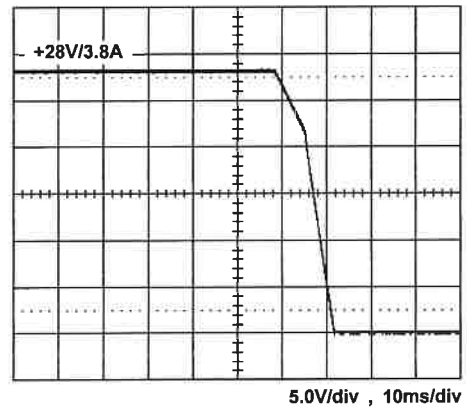

8.5 Hold-up time

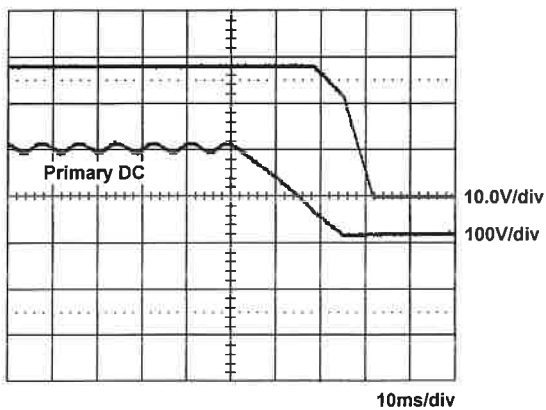

8.6 Over voltage protection

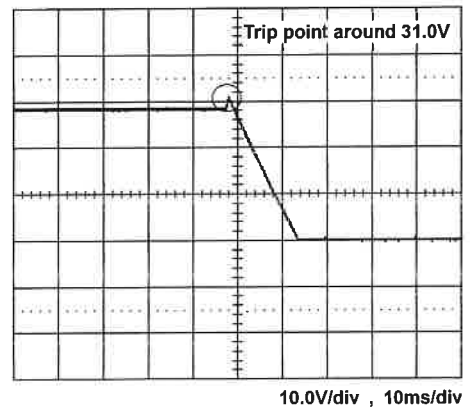

8.7 +28V step response

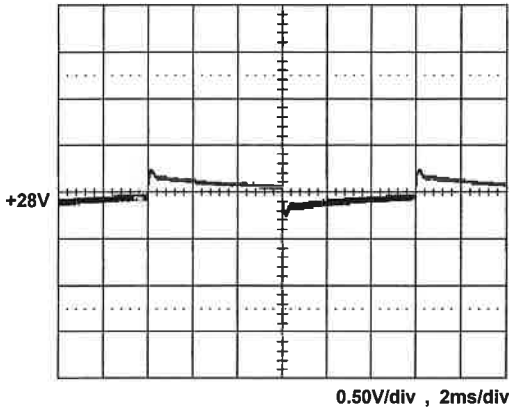

+28V step from 0.76A to 3.8A

8.8 FCC B performance

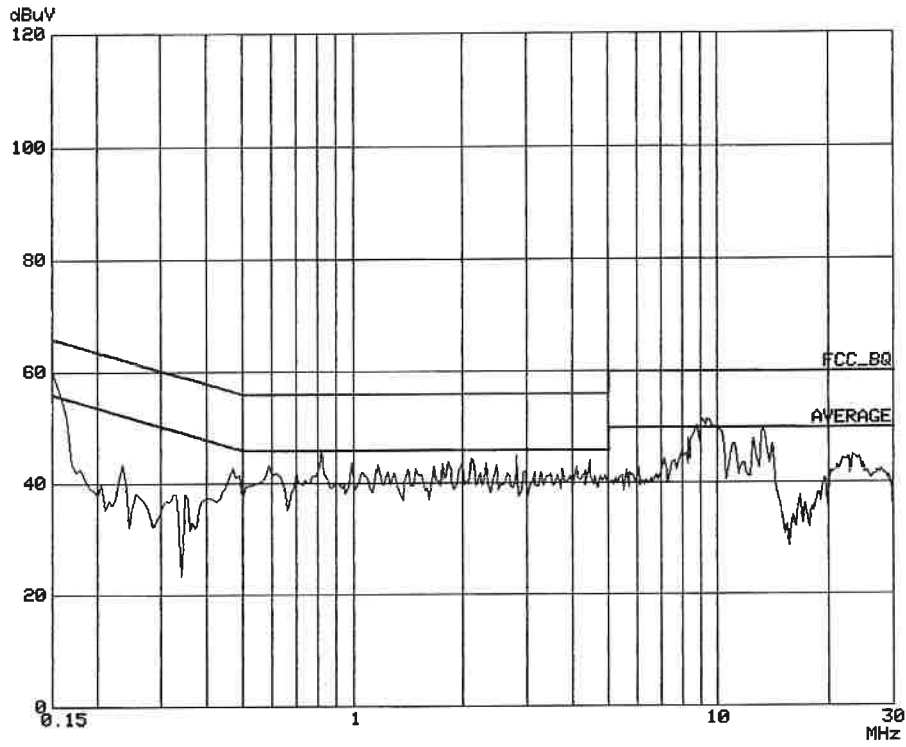

8.9 CISPR 22 B

